

4" Square Mailbox Post (Models 5105, 5106, 5525 and 5526) Assembly Instructions

Thank you for purchasing this premium mailbox post. We know you'll be satisfied with the years of service it will provide. If you have any questions about how to assemble or install this product, or if you need any replacement parts, please call us directly at (800) 824-9985 or contact us at www.mailboxworks.com

Assembly Instructions



IMPORTANT! Some mailbox installations are regulated by the United States Postal Service. There are often height and placement restrictions. Refer to the instructions included with the mailbox **BEFORE INSTALLING THIS POST** to ensure proper installation. The installation instructions included on this sheet provide guidance on how to install the post only and do not cover specific mailbox installation.

Tools

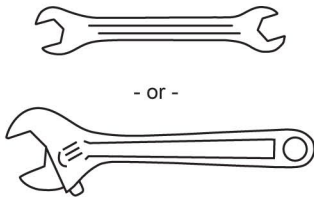
Two Crescent or Open End Wrenches
(not included)



Hardware

-  x 4, hex bolts
-  x 8, washers
-  x 4, nuts

Attach the mailbox to the post using the 4 bolt sets included with the post, as shown below. Be sure to use the washers.

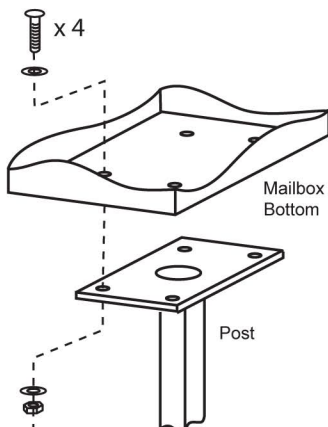

IMPORTANT! If unfamiliar with how to properly form and pour concrete, consult a qualified mason or carpenter for assistance.

For In-ground Posts (items 5105 and 5525):

Dig a hole deep enough to allow proper mailbox installation according to the instructions included with the mailbox. The final height and placement of the mailbox is often dictated by the United States Postal Service, which will be described in the instructions that came with your mailbox. If your mailbox did not come with installation instructions, contact your local Post Office for installation details **BEFORE CONTINUING**.

Pour concrete (at least 1 cubic foot recommended) completely around the post. Allow concrete to set before use.

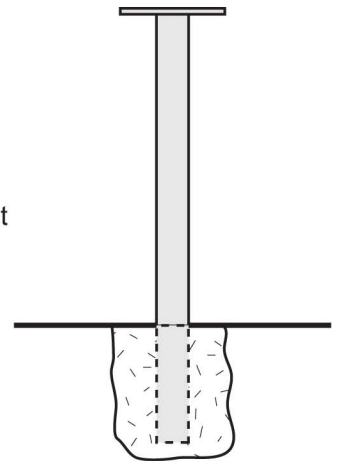

For Surface Mount Posts (items 5106 and 5526):

J-Bolts and Concrete Anchors are not included for this installation.

The final height and placement of the mailbox is often dictated by the United States Postal Service, which will be described in the instructions that came with your mailbox. If your mailbox did not come with installation instructions, contact your local Post Office for installation details **BEFORE CONTINUING**.

For a new concrete pad, pour the concrete in your desired form and insert j-bolts into the wet concrete in the correct 4" x 10" bolt pattern. Allow concrete to set before attaching the post. For an existing concrete pad, install concrete anchors in the correct 4" x 10" bolt pattern and attach the post to the anchors.

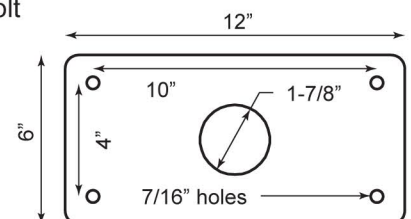
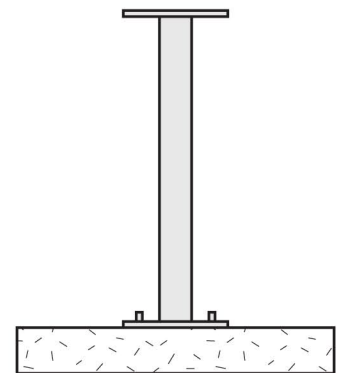

The Mailbox Works

www.mailboxworks.com (800) 824-9985