

**MINI42FS Dimensions**

Overall Width w/ Trim: 12-1/8"

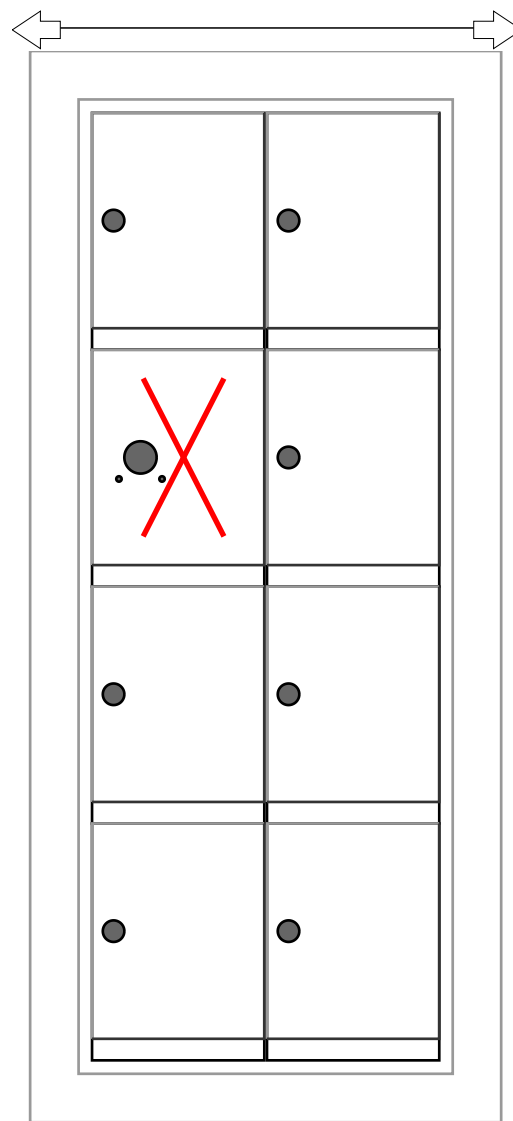

**MINI42FS**

**Side View**

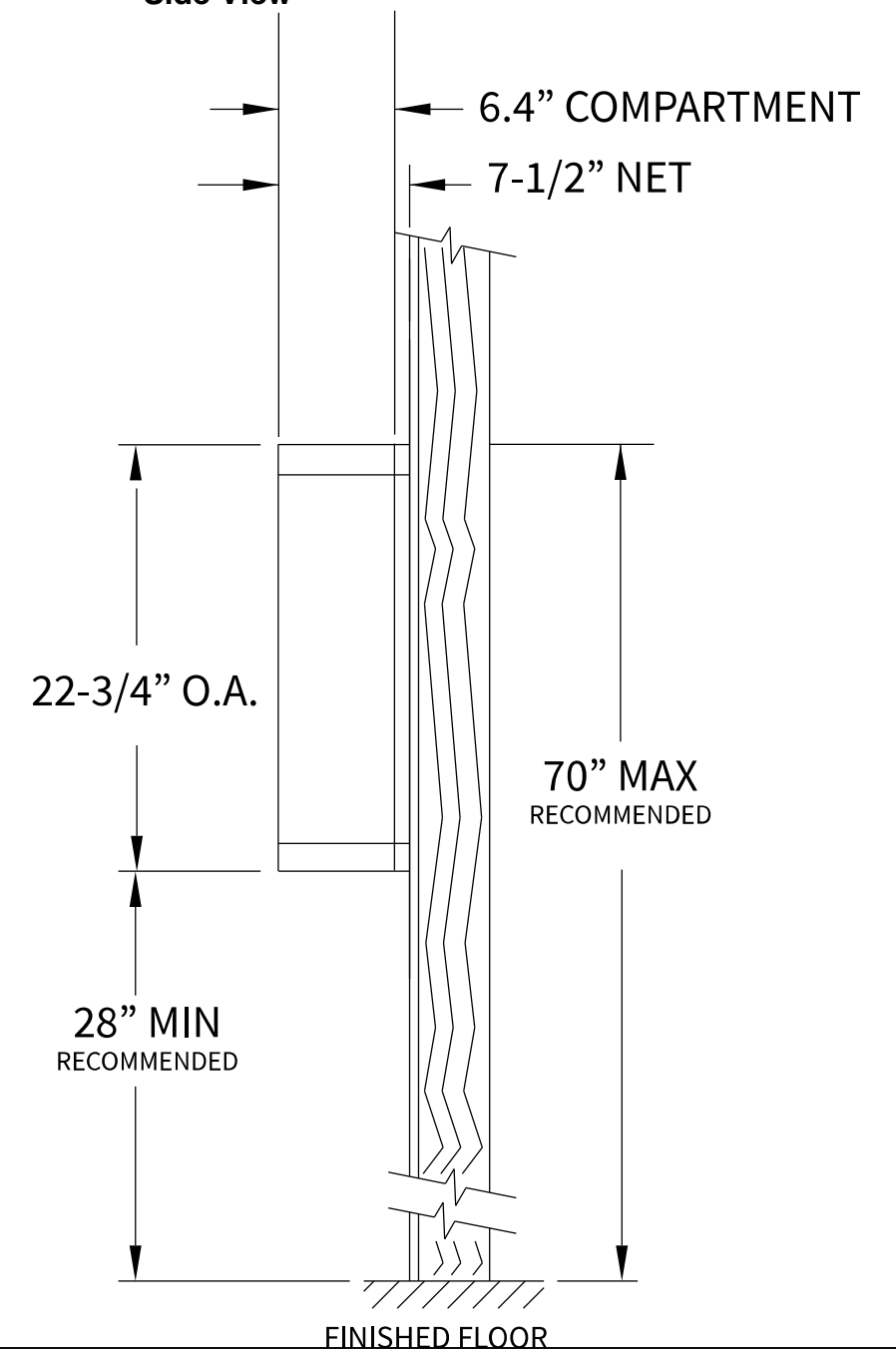

**Configuration Details:**

- 1. **Product Type:** Mini Storage Locker
- 2. **Installation:** Front-load, Surface Mount
- 3. **Finish:** Anodized Aluminum
- 4. **Locks:** Standard Cam Lock, 2 keys
- 5. **Door Id:** tbd

Matching standard snap-on trim included

**Models Used:**

(1) MINI42FS

**DO NOT SCALE OFF DRAWING**

**Door Sizes Used:**

(7) MINI-A 1x1 Compartment  
(1) 1x1 Master

**ELEVATION:** MINI42FS | **LOCKERS:** 7 |

**PROJECT NAME:** Mini Storage Lockers | **DRAWN BY:** FLORENCE



1743 Quincy Ave. Suite 151  
Naperville, IL 60540  
800-824-9985  
www.MailboxWorks.com

<b>DATE:</b> 01-15-2016	<b>P.O. NO:</b>
<b>SCALE:</b> NONE	<b>QUOTE NO:</b>
<b>DRAWING NO.</b> WEB-1932	<b>SHEET 1 OF 1</b>