

MINI42F Dimensions

Overall Width w/ Trim: 12-1/8"
(Rough Opening: 9-7/8")

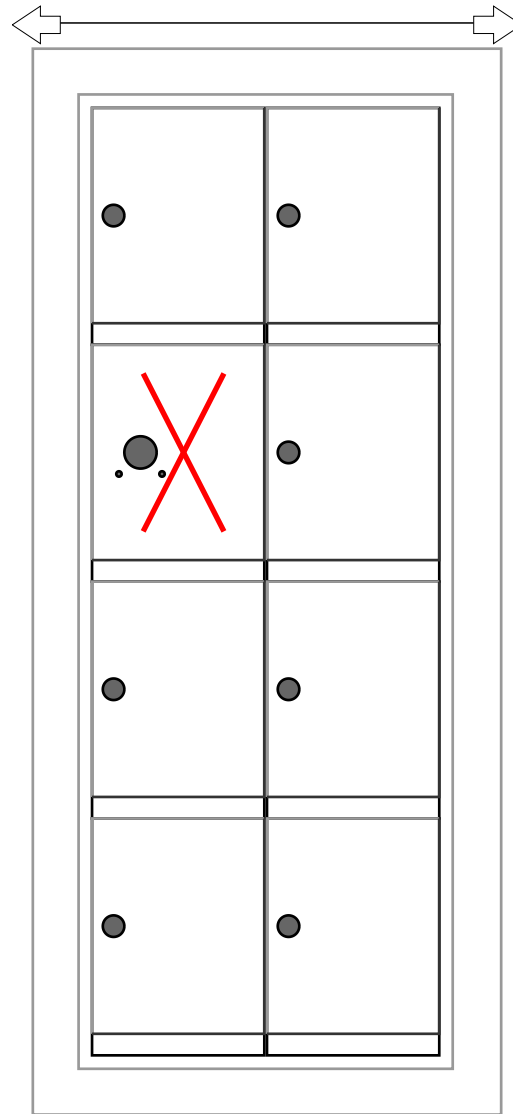

MINI42F

Side View

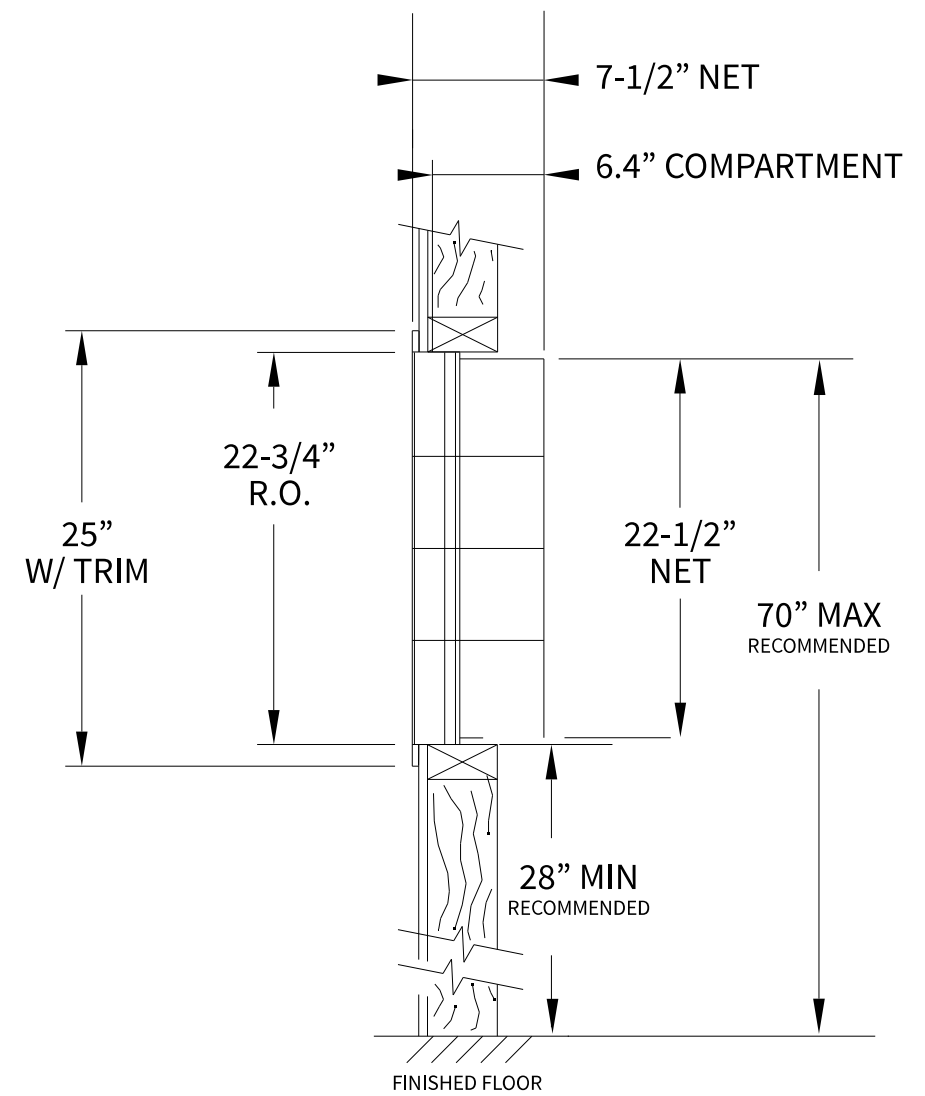

Configuration Details:

- 1. **Product Type:** Mini Storage Locker
- 2. **Installation:** Front-load, Recessed Mount
- 3. **Finish:** Anodized Aluminum
- 4. **Locks:** Standard Cam Lock, 2 keys
- 5. **Door Id:** tbd

Matching standard snap-on trim included

Models Used:

(1) MINI42F

DO NOT SCALE OFF DRAWING

Door Sizes Used:

(7) MINI-A 1x1 Compartment
(1) 1x1 Master

ELEVATION: MINI42F | **LOCKERS:** 7 |

PROJECT NAME: Mini Storage Lockers | **DRAWN BY:** FLORENCE



1743 Quincy Ave. Suite 151
Naperville, IL 60540
800-824-9985
www.MailboxWorks.com

DATE: 01-15-2016	P.O. NO:
SCALE: NONE	QUOTE NO:
DRAWING NO. WEB-1932	SHEET 1 OF 1