

Patented FAST-TRAK® mounting plate makes installation easy. Fits almost any post or platform.

Customers should contact the local post office or mail carrier before installing the mailbox to ensure its correct placement and height at the street. Generally, mailboxes are installed at a height of **41-45 inches from the road surface** to the inside floor of the mailbox or point of mail entry and are **set back 6-8 inches from the front face of the curb** or road edge to the mailbox door.

METAL POST

Attach FAST-TRAK® plate to metal post using four bolts.

- 1** Separate the mounting plate from the Mail Boss® by removing the 2 machine screws located inside the locking door of Mail Boss®. Position the mounting plate so that the four pre-drilled holes in the post line up with the holes on the plate. Be sure the ear of the mounting plate is towards the front.

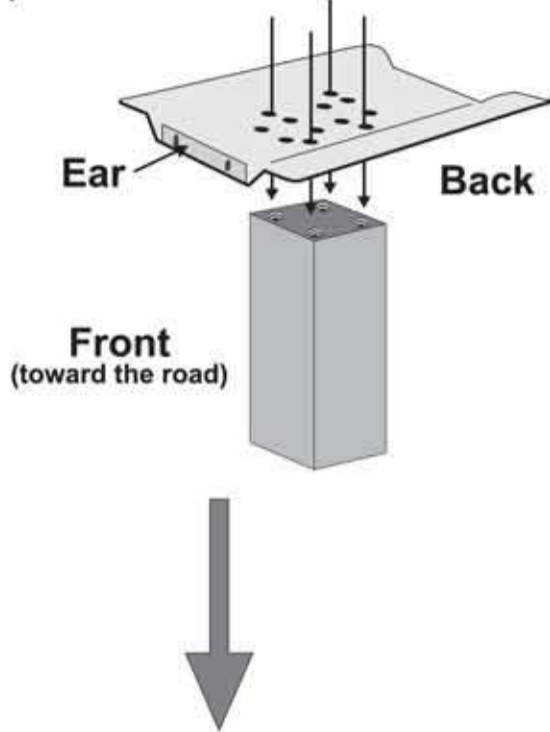

- 2** Attach the mounting plate to the post using the four machine bolts that came with the post. A drive socket, wrench or crescent wrench may be used to tighten and secure the bolts to the Fast-Trak® mounting plate.

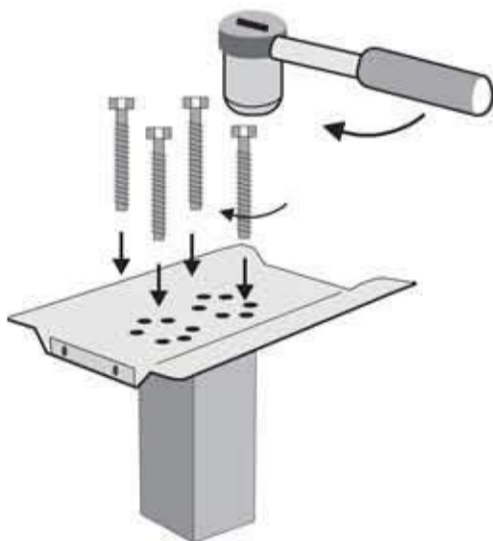

WOOD POST

Drill four pilot holes using drill bit provided and attach FAST-TRAK® plate with four lag screws provided.

- 1** Separate the mounting plate from the Mail Boss® by removing the 2 machine screws located inside the locking door of Mail Boss®. Place the mounting plate so that it is centered over the wood platform. Be sure the ear of the mounting plate is towards the front. Position the ear of the mounting plate about 1" behind desired location of the front face of the Mail Boss®.

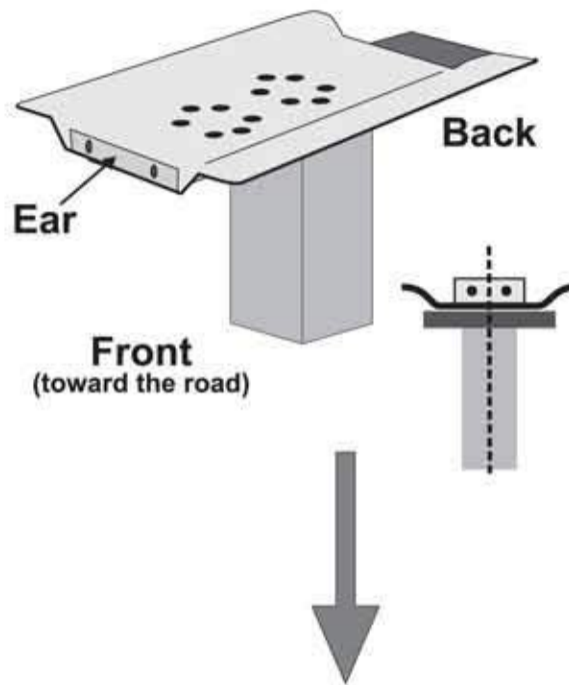

- 2** Choose four holes on the mounting plate that are furthest away from each other and yet are still on top of the wood platform. Mark their location on the wood. Using the drill bit provided, drill four pilot holes approximately 1½" inches deep into the wood.

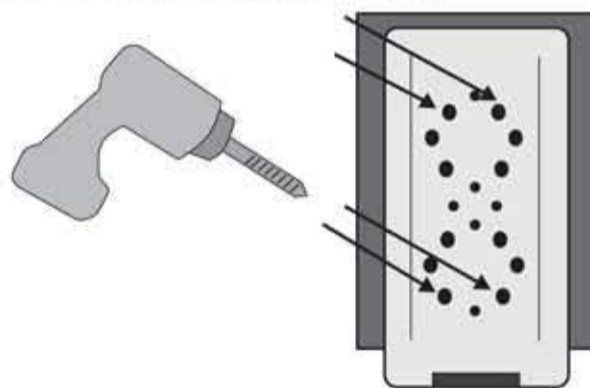

- 3** Attach the Fast-Trak® mounting plate to the platform using four 1½" lag screws. A 13mm drive socket, 13mm wrench or crescent wrench may be used. Alternatively, the mounting plate has smaller holes which may be used for attachment with generic wood screws.

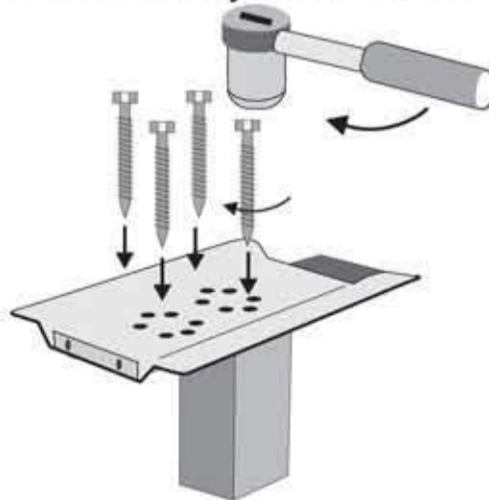

WOOD GANG PLANK

Drill four pilot holes using drill bit provided and attach FAST-TRAK® plate with four lag screws provided.

- 1** Separate the mounting plate from the Mail Boss® by removing the 2 machine screws located inside the locking door of Mail Boss®. Locate a space on the plank approximately 14" wide. Place the mounting plate with equal spacing on the left and right side. Be sure the ear of the mounting plate is towards the front and is approximately 1" back from the front plane of adjacent mailboxes.

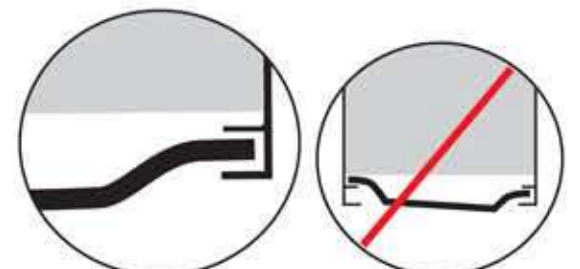
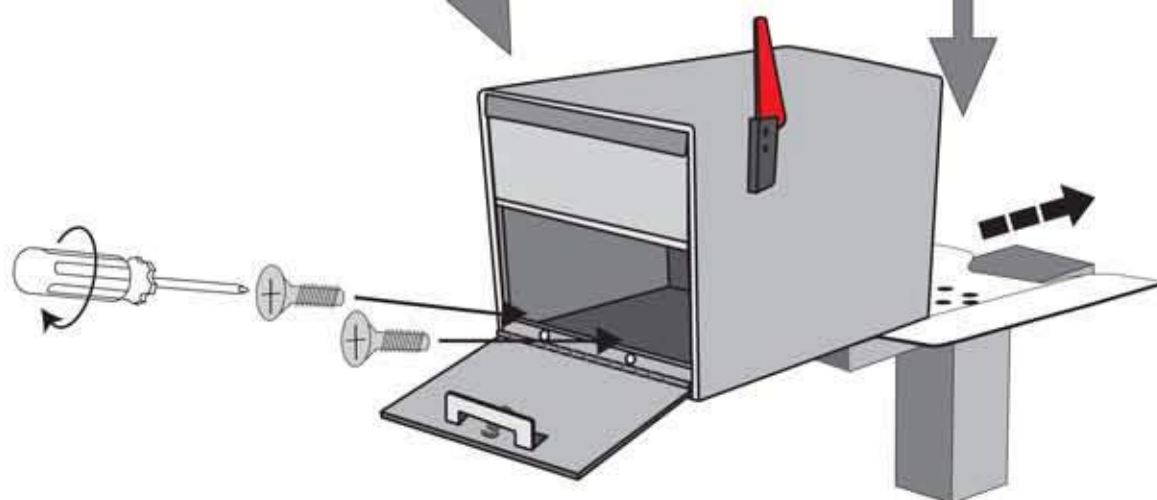
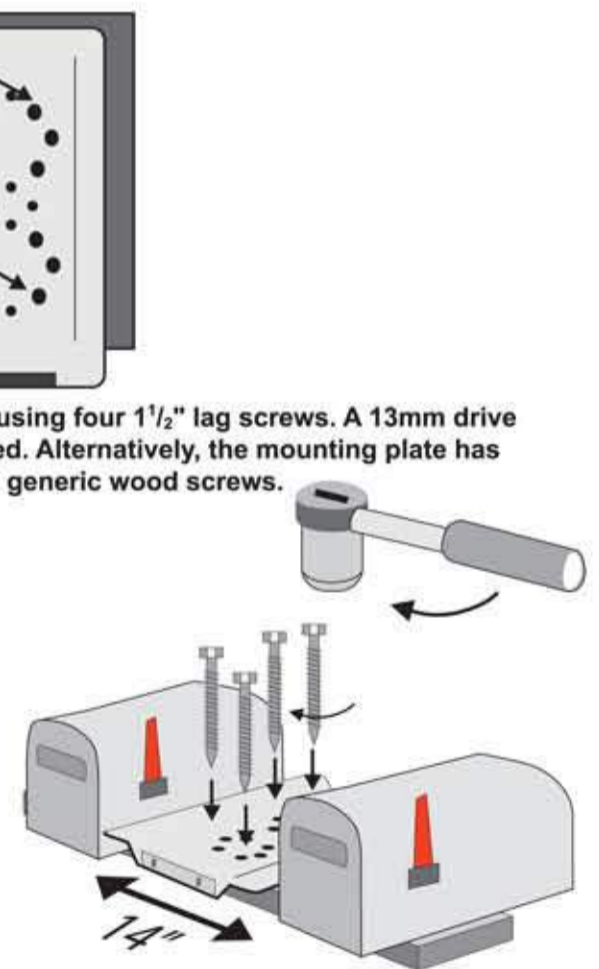
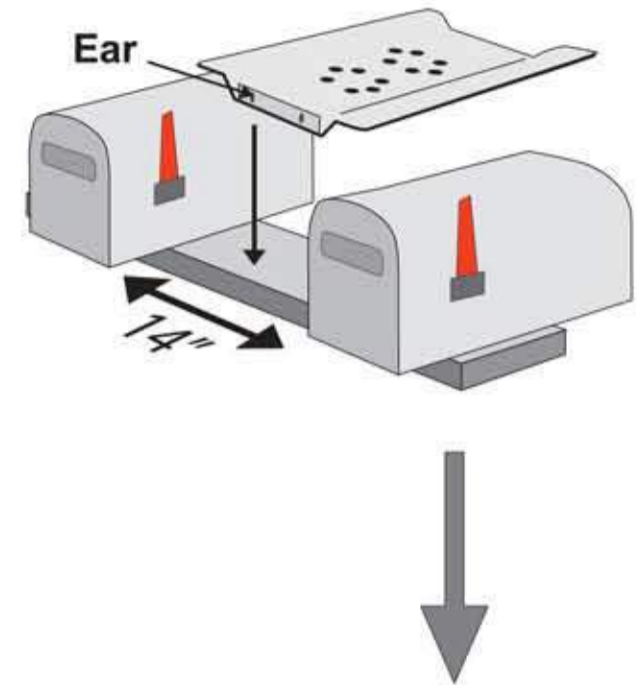

Simply slide MAIL BOSS® onto FAST-TRAK® mounting plate and secure with two machine screws provided.