

### 170075 Dimensions

Overall Width w/ Trim: 24-3/8"  
(Rough Opening: 22-1/8")

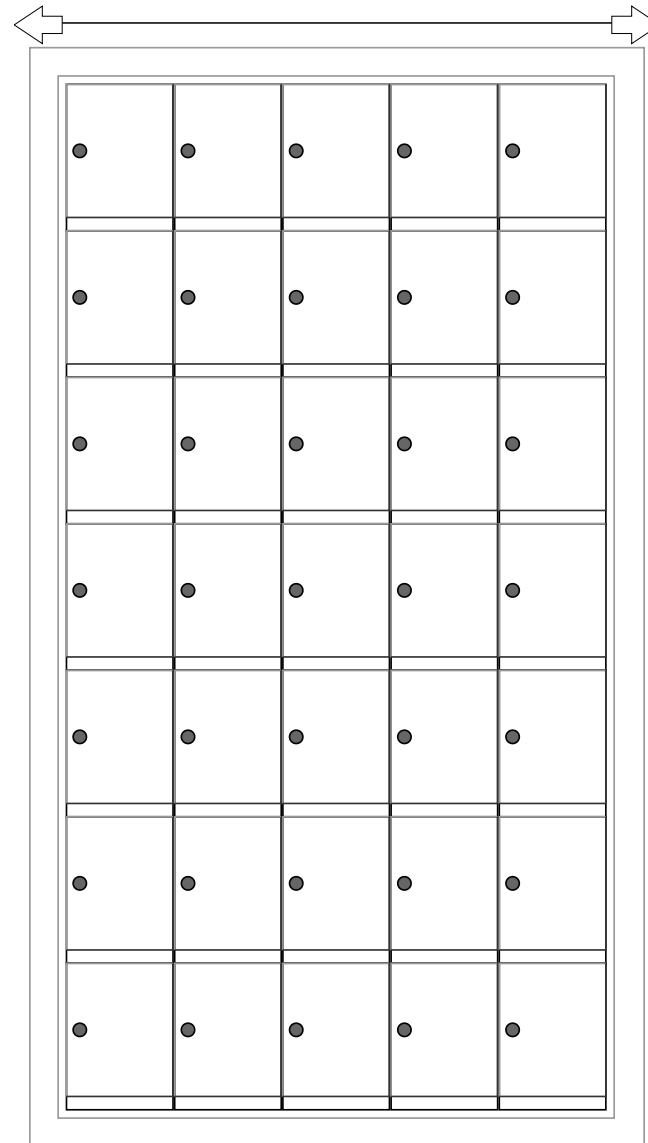

170075

### Side View

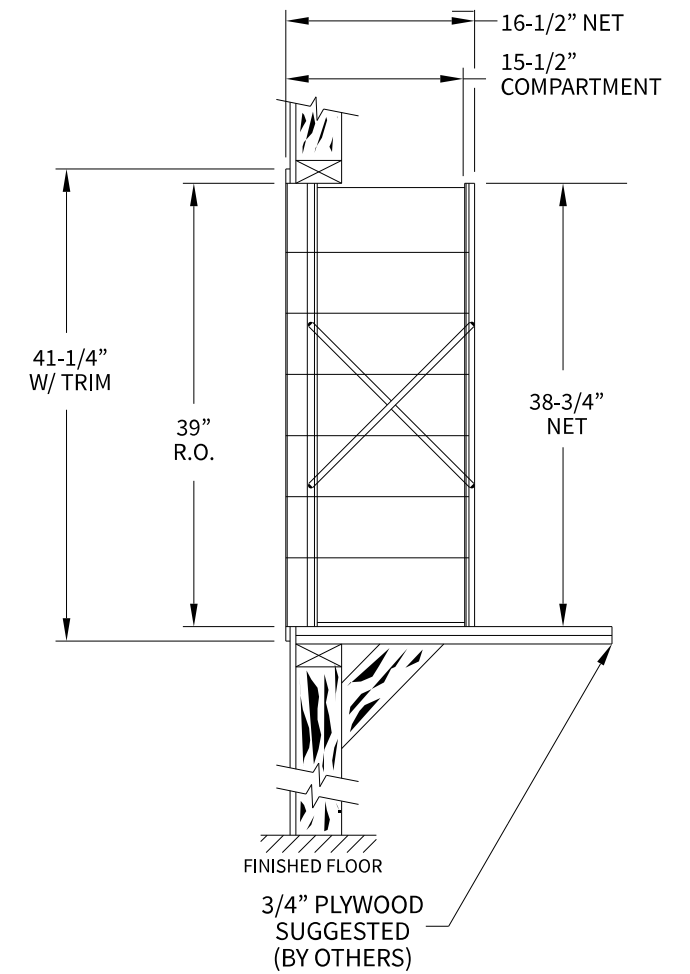

#### Configuration Details:

1. **Product Type:** 1700 Horizontal
2. **Installation:** Rear-load, Recessed Mount
3. **Finish:** Anodized Aluminum
4. **Locks:** Standard Cam Lock, 2 keys
5. **Door Id:** tbd
6. **Rear Cover:** tbd

Matching standard snap-on trim included

#### Models Used:

(1) 170075

**DO NOT SCALE OFF DRAWING**

#### Door Sizes Used:

(35) 1700 1x1 Compartment

**ELEVATION:** 170075 | **MAILBOXES:** 35 |

**PROJECT NAME:** 1700 Series Mailbox

**DRAWN BY:** FLORENCE

**The Mailbox Works**

1743 Quincy Ave. Suite 151  
Naperville, IL 60540  
800-824-9985  
www.MailboxWorks.com

**DATE:** 01-15-2016

**P.O. NO:**

**SCALE:** NONE

**QUOTE NO:**

**DRAWING NO.** WEB-1932

**SHEET 1 OF 1**