

**1700125 Dimensions**

Overall Width w/ Trim: 24-3/8"  
(Rough Opening: 22-1/8")

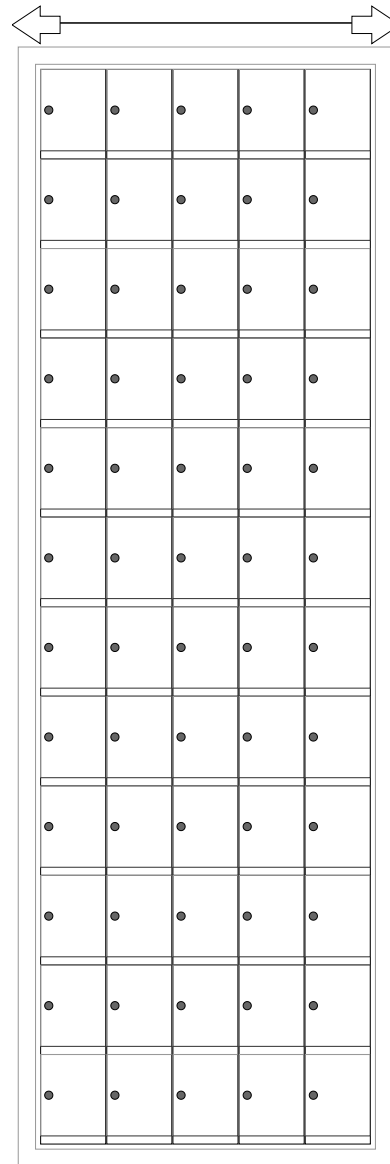

1700125

**Side View**

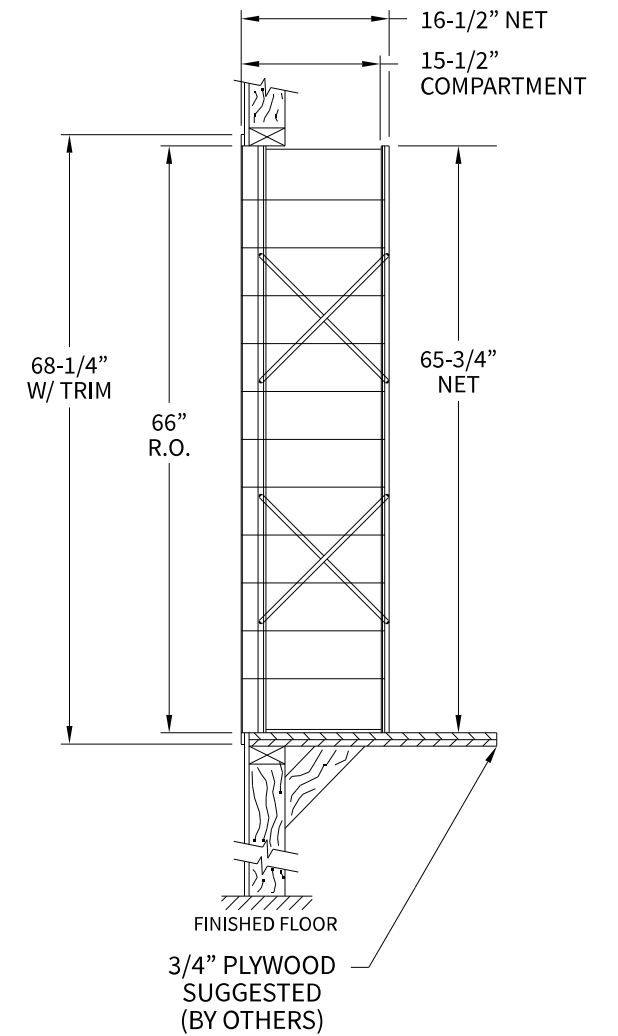

**Configuration Details:**

- 1. **Product Type:** 1700 Horizontal
- 2. **Installation:** Rear-load, Recessed Mount
- 3. **Finish:** Anodized Aluminum
- 4. **Locks:** Standard Cam Lock, 2 keys
- 5. **Door Id:** tbd
- 6. **Rear Cover:** tbd

Matching standard snap-on trim included

**Models Used:**

(1) 1700125

**Door Sizes Used:**

(60) 1700 1x1 Compartment

**DO NOT SCALE OFF DRAWING**

**ELEVATION:** 1700125 | **MAILBOXES:** 60 |

**PROJECT NAME:** 1700 Series Mailbox | **DRAWN BY:** FLORENCE



1743 Quincy Ave. Suite 151  
Naperville, IL 60540  
800-824-9985  
www.MailboxWorks.com

<b>DATE:</b> 01-15-2016	<b>P.O. NO:</b>
<b>SCALE:</b> NONE	<b>QUOTE NO:</b>
<b>DRAWING NO.</b> WEB-1932	<b>SHEET 1 OF 1</b>