

160094 Dimensions

Overall Width w/ Trim: 20-5/16"
(Rough Opening: 18-1/16")

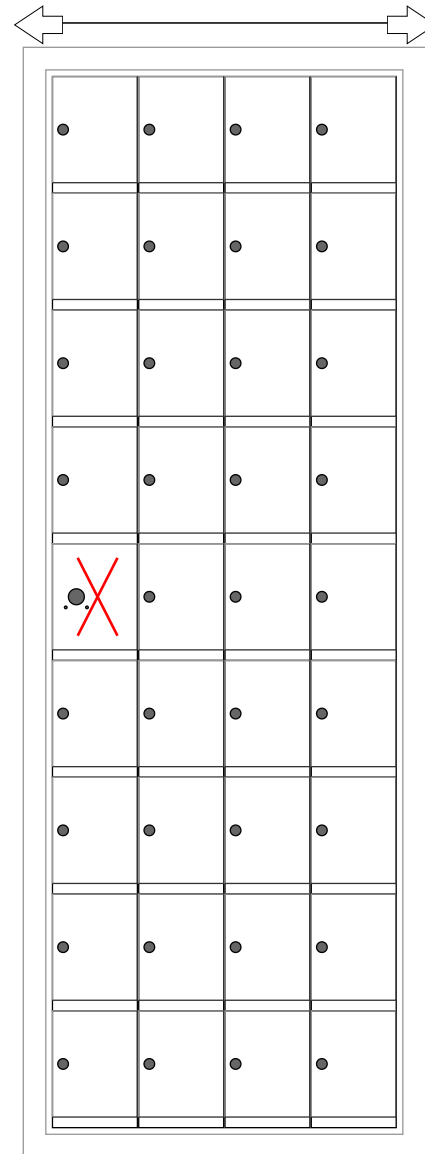

160094

Side View

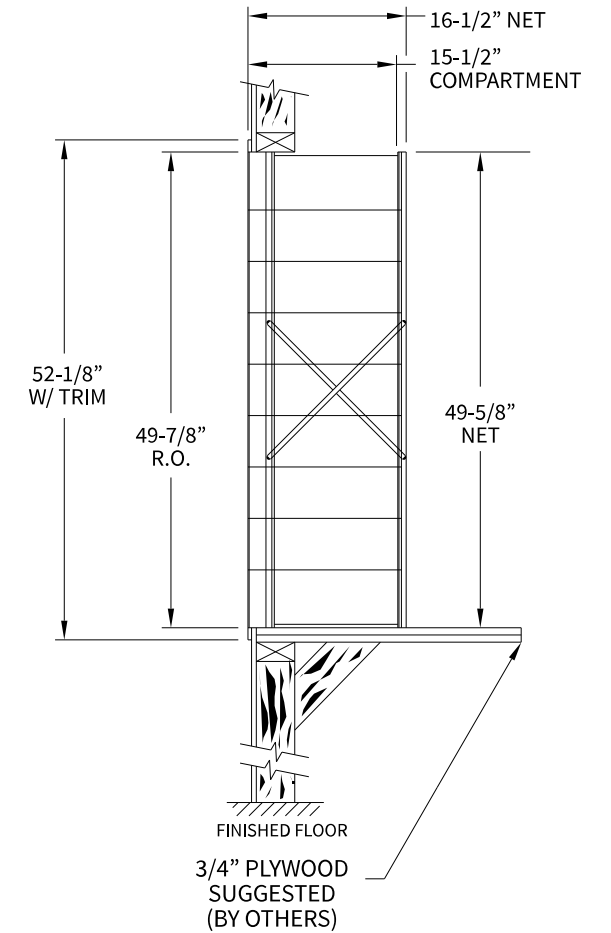

Configuration Details:

- 1. **Product Type:** 1600 Horizontal
- 2. **Installation:** Front-load, Recessed Mount
- 3. **Finish:** Anodized Aluminum
- 4. **Locks:** Standard Cam Lock, 2 keys
- 5. **Door Id:** tbd

Matching standard snap-on trim included

Models Used:

(1) 160094

DO NOT SCALE OFF DRAWING

Door Sizes Used:

(35) 1600 1x1 Compartment
(1) 1x1 Master

ELEVATION: 160094 | **MAILBOXES:** 35 |

PROJECT NAME: 1600 Series Mailbox | **DRAWN BY:** FLORENCE



1743 Quincy Ave. Suite 151
Naperville, IL 60540
800-824-9985
www.MailboxWorks.com

DATE: 01-15-2016	P.O. NO:
SCALE: NONE	QUOTE NO:
DRAWING NO. WEB-1932	SHEET 1 OF 1