

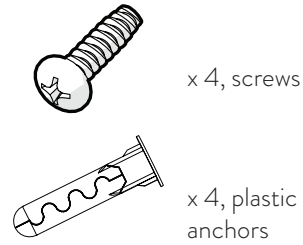

IMPORTANT! This mailbox is intended to be mounted under an eave or another protected area.

Hardware (included)



Tools (not included)

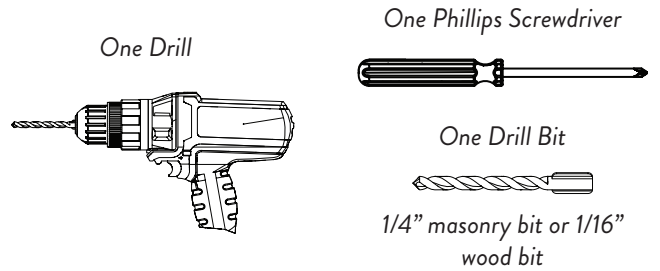

- Using the guide on the back of these instructions, mark the wall at the center of each crosshair. Use a level to ensure a straight installation (optional).

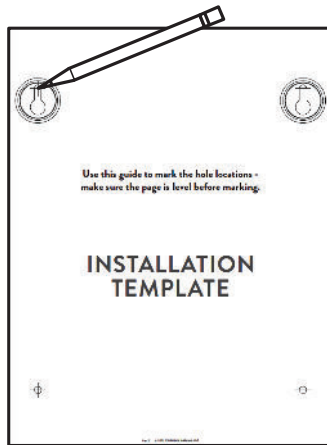

- Drill into the wall at each marked location. Use a 1/4" drill bit for brick or other masonry wall. Use a 1/16" drill bit for wood wall.

1/4" masonry bit
- or -
1/16" wood bit

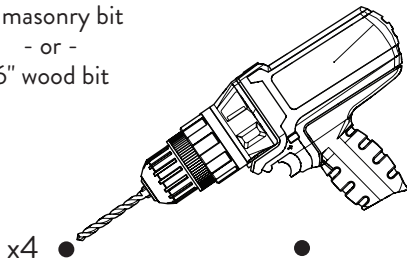

- Skip this step if installing into wood.**

Insert the included plastic anchors into the drilled holes. Gently tap them in if necessary.

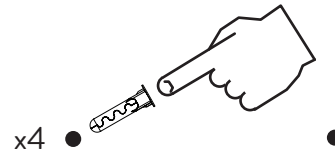

- Insert the screws into the top two drilled holes and secure with a screwdriver. Hang the mailbox onto the secured screws using the top eyelet holes on the back of the mailbox.

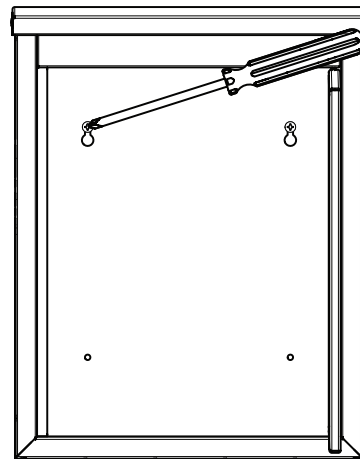

- While the mailbox is hanging on the top screws, insert the remaining two screws into the bottom holes and secure with a screwdriver.

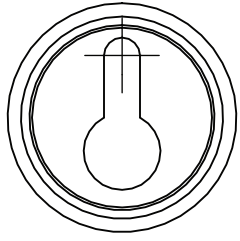
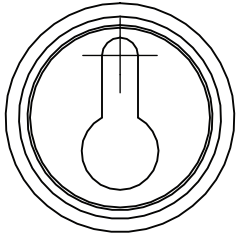

**Use this guide to mark the hole locations -
make sure the page is level before marking.**

INSTALLATION TEMPLATE

