

170096 Dimensions

Overall Width w/ Trim: 28-7/16"
(Rough Opening: 26-3/16")

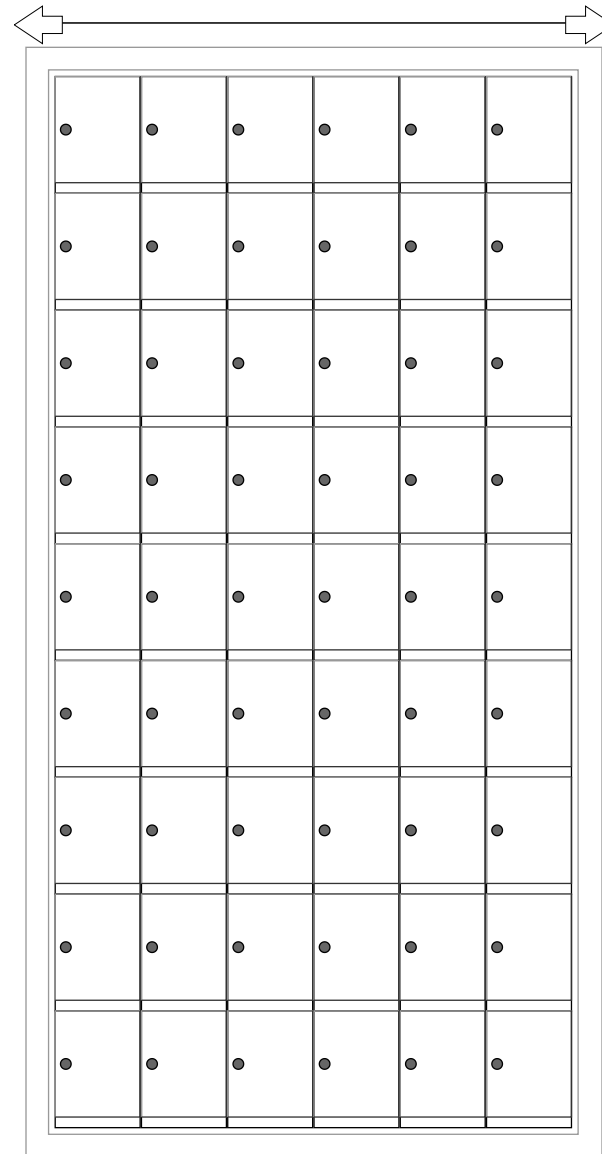

170096

Side View

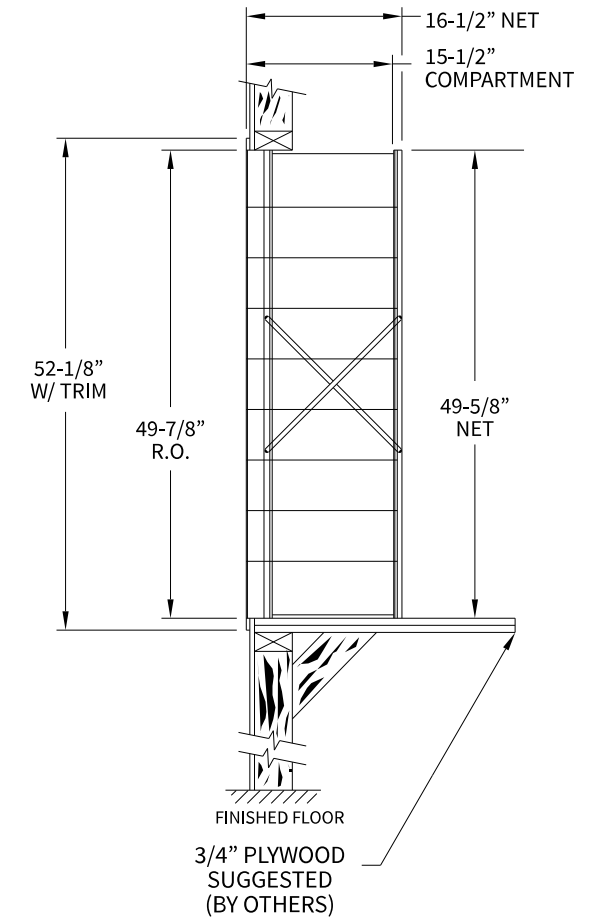

Configuration Details:

- 1. **Product Type:** 1700 Horizontal
- 2. **Installation:** Rear-load, Recessed Mount
- 3. **Finish:** Anodized Aluminum
- 4. **Locks:** Standard Cam Lock, 2 keys
- 5. **Door Id:** tbd
- 6. **Rear Cover:** tbd

Matching standard snap-on trim included

Models Used:

(1) 170096

Door Sizes Used:

(54) 1700 1x1 Compartment

DO NOT SCALE OFF DRAWING

ELEVATION: 170096 | **MAILBOXES:** 54 |

PROJECT NAME: 1700 Series Mailbox | **DRAWN BY:** FLORENCE



1743 Quincy Ave. Suite 151
Naperville, IL 60540
800-824-9985
www.MailboxWorks.com

DATE: 01-15-2016	P.O. NO:
SCALE: NONE	QUOTE NO:
DRAWING NO. WEB-1932	SHEET 1 OF 1